



NOVEA

GROUPE RAGNI

SOLAR LIGHTING,
DESIGNED TO LAST

**SOLAR
CATALOGUE**

CONTENTS

1

PRESENTATION

03

2

OUR COMBI TOP RANGE

13

3

TECHNICAL SPECIFICATIONS

31

4

OPTIONS

37

5

OUR ACHIEVEMENTS

45

6

OUR COMMITMENTS

51

PRESENTATION



SOLAR PUBLIC LIGHTING :

A SUSTAINABLE SOLUTION



100% Autonomous lighting

Total independence from the electrical grid and its overloads.

A secure solution

Ideal for providing rapid security for isolated areas and sensitive sites.

Guaranteed savings

No trenches, no cabling, no grid connection. A very profitable solution thanks to the long lifecycle of the components, the absence of energy expenses and nearly non-existent maintenance.

A highlighted environmental process

Seen by everyone, this solar public lighting furniture will perfectly represent your sustainable development policy.

Reduced environmental impact

No CO2 emissions, no use of fossil energy sources for operating, a preserved installation site and avoidance of light pollution.

Social and economic advantage

Solar public lighting is a vehicle for economic and social development as it enables the residents to keep their outdoor activities up during the night. The comfort and security provided by public lighting make it possible to reinforce the social bond and to favour the development of trade and restaurant activities in the evening.

Made in France

Novéa Énergies and Ragni Group to which we belong, are committed to highlighting French know-how and quality. Thus, the manufacture of our autonomous street lights involves several French companies as well as local sheltered workshops. This commitment is reflected in our membership of the French Fab.





FRENCH SPECIALIST OF AUTONOMOUS LIGHTING SOLUTIONS SINCE 2007

GROUPE
RAGNI



NOVEA



Leader in design and manufacturing of autonomous solar lighting systems

Precursor in France and Europe, we will spare no effort to provide qualitative products and unique support. Confident in our solutions, we offer the best lifespan and warranties of the market. Subsidiary of RAGNI Group since 2015, we are able to use solar energy to power reliable luminaires.

With thousands of references around the world, we have a mastered know-how that we develop thanks to a network of partners present in each country.



OUR SERVICES

WHAT YOU EXPECT FROM AN
AUTONOMOUS LIGHTING EXPERT

Manufacturing and commercialising innovating public lighting needs a high level of multiples and specific skills.

Developing a great attentiveness to our clients and partners, our technical and commercial organisation is the reflection of the support you have the right to expect from an autonomous lighting specialist.

TECHNICAL SUPPORT

For a perfect installation

- Phone support : we reply to your diagnosis demands and to all your questions about the sizing, installation and maintenance of your autonomous lighting solution.
- On-site support : we move on site for the technical presentation, setting up validation, training or specific intervention.
- Replacement parts : as a manufacturer, we want to control our solutions at 100%. This is why we have a permanent stock on parts, which enables us to deliver rapidly a client in case of needs.

ORGANISATION

A complete team dedicated to the
global management of your project

- Local commercial unit in France and worldwide
- Research and Development department
- Commercial and technical design office
- Logistics unit
- Photometric laboratory
- Manufacture of batteries and luminaires, treatment of brackets and poles for public lighting
- Quality department

TRAINING

For a local transfer of skills

- Complete training provided to local companies
- Technical training for a high-level maintenance

N



ISO 14001 is a standard that establishes the requirements for an effective environmental management system. It provides a framework for setting up an environmental policy, planning the actions to be taken, implementing these actions and verifying their effectiveness.



ISO 9001 is an internationally recognized standard that establishes requirements for an effective quality management system. It is based on the principle of continuous improvement, which consists of identifying opportunities for improvement and implementing actions to exploit them.

OUR PRODUCTION SITE

DEDICATED TO THE MANUFACTURE OF OUR EXCLUSIVE NOVBOX* AND TO THE ASSEMBLY OF LUMINAIRES!



TWO EFFICIENT PRODUCTION LINES



Receipt of components

Every component is checked upon receipt to ensure its conformity with our quality requirements.



Assembly of the luminaire

PCB LED, optics, seals and safety glass.



Luminaire test

To approve the cabling and the good operating of the PCB LED.

Set up of the NOVBOX

Programming of the circuit board. Setting up of connectors, seals, wedging foam for batteries, batteries, electronic board and cabling.



Traceability

Unique number assigned to the NOVBOX.



NOVBOX test

With a test bench which realises an entire operating cycle (battery voltage, solar charge, operating driver LED, control power/tension).



Shipping

The components are packed and placed on a pallet. Then it is strapped, wrapped and labelled with the list of items.



* more information p32

A RELIABLE PROCESS



Ergonomics

Optimized production line
Antistatic and antifatigue mats



Traceability

Serial number + QR Code
of our NOVBOX



Adaptability

Many possible
configurations



Testing

Luminaire and NOVBOX,
in real conditions



**AN EXCLUSIVE
TRIPLE MASTERY,
ESSENTIAL FOR
TECHNICAL
ANGLE**



**YOUR
PROJECT,
OUR EXPERT
APPROACH**

Mastery of

ENERGY MANAGEMENT

- Production of precise and transparent energy studies
- Design of long-lasting batteries : endurance + (more information p.32)
- Expertise in managing the energy flows

Mastery of

ELECTRONICS

- Design and development of our own managing electronics
- Optimisation of efficiency by the expertise in algorithms and the choice of components

Mastery of

PUBLIC LIGHTING

- Production of personalised photometric studies
- Design and manufacturing of reliable and robust luminaires, equipped with the best LED of the market (experience and innovations provided by Ragni)
- Poles in compliance with EN40 and Eurocode 1991-1-4 (to integrate fatigue)

A scientific approach of our autonomous lighting solution

Your statement of need, prerequisite to our proposition of a technical solution

On the expected application (dimensions of the area to light, lighting level need, period and length of operating) depends the sizing of your solar lighting solution.

This is why we put the support at the heart of our project approach and we help you from the statement of your need to the definition of the best technical solution. Design and aesthetics besides.



1 PRESENT US YOUR PROJECT

WE ANALYSE YOUR NEEDS PRECISELY

2 WE PERFECTLY SIZE

YOUR PROJECT TO ORDER USING 3 COMPLEMENTARY STUDIES FOR A SOLUTION THAT PROVIDES LIGHTING ALL OVER THE YEAR.

ENERGY study enables to:

Size the solar panel according to the chosen tilt :

- by analyzing the sunshine potential of the site
- by checking that the energy production of solar panels is superior to energy consumption of the luminaire (at least + 25 %, to anticipate the panel ageing, its production decrease and its potential clogging depending on geographical area)

Size the energy capacity of the battery :

- by choosing the number of nights of autonomous operation without sunlight (until 10 depending on geographical area)
- by analyzing the annual average discharge rate to validate the service life

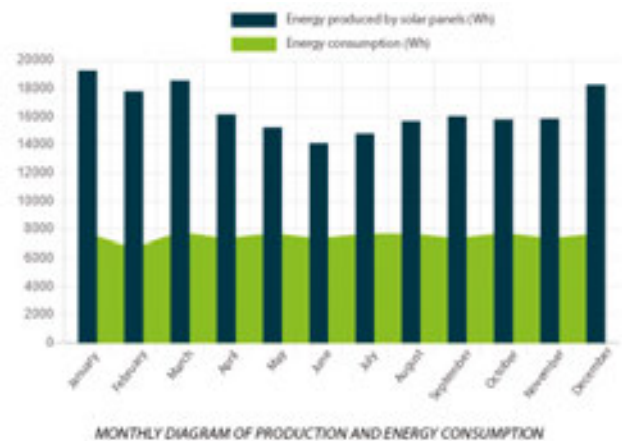

Developed internally, our software integrates the meteorological database Retscreen : it lists thousands of weather stations across the world to calculate energy production of a solar panel, according to its situation worldwide.

Did you know ?

Energy study is always based on the most unfavourable period of the year.



Your **LIGHTING** needs

- Which application?
- Which area to light?
- Which lighting level need?



Your **USE**

- How long (period, length) ?
- Which scenario ?



Which **CONDITIONS**

- Where is the project ?
- What is the solar potential on the site ?



The more energy-efficient will be the use, the more reasonable will be the sizing of solar street light.

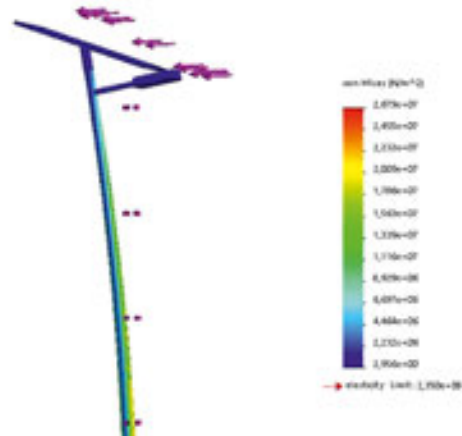
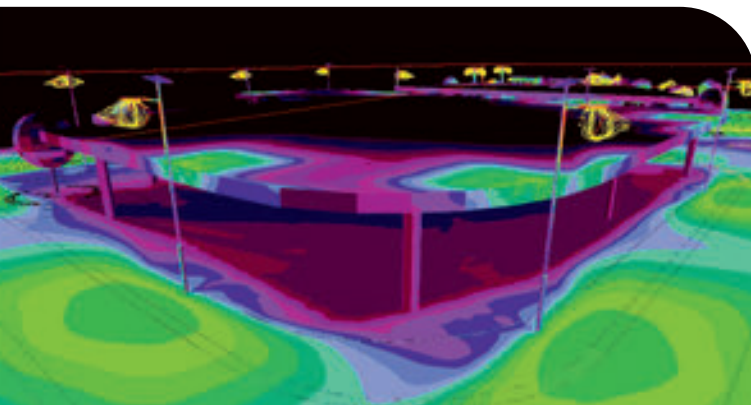

PHOTOMETRIC study enables to:

- Respect the applicable recommendations and norms (EN13201, decree of 27/12/2018, about light pollution)
- Decide on capacity, number of LED, photometric distribution and light height
- Optimise the number of lighting poles



Photometric study is realised by our own design office.

MECHANICAL study enables to:



- Respect EN 40-3 norm and Eurocode 1991-1-4 technical recommendations of Industrial Technical Centre of Mechanical Construction (integrate a fatigue calculation) according to solar lighting specific constraints
- Adapt pole technical characteristics and its concrete foundation according to its environment
- Install safely and durably the lighting pole



NF 40-3 norm clarifies the specifications of the calculation about public lighting poles. Our calculation process is in compliance with EN40-3.

3 AN AUTONOMOUS LIGHTING SOLUTION

SIZED ACCORDING TO YOUR NEEDS...

Functional, residential, traditional, design... the combinations of RAGNI **luminaires** range, **brackets** and pole finishing, combined with large possibilities of customisation, make your solution a **unique solar lighting pole**.



The graphic integration realised by our marketing department allows the project to be validated before installation.

... AT THE BEST GLOBAL COST ON THE MARKET

EFFICIENT

The best autonomy on the market

- Operating all over the year with the same level of efficiency.
- Easy setting, reduced installation time.

PROFITABLE AND SUSTAINABLE

The best lifetime on the market

- Reduced investment costs: 0 € for trench, cable, electrical cabinet, and connection.
- Controlled operating costs: no energy bill, heavy maintenance, cleaning.

SMART

A secured and adapted lighting

- Wide choice of programming: dimming, motion sensor, switch off,...
- Remote management (NOVEA CONTROL optional)



**OUR
COMBI TOP RANGE**

2

STREET LIGHTING SOLUTION

DEPENDENT ON SIZING

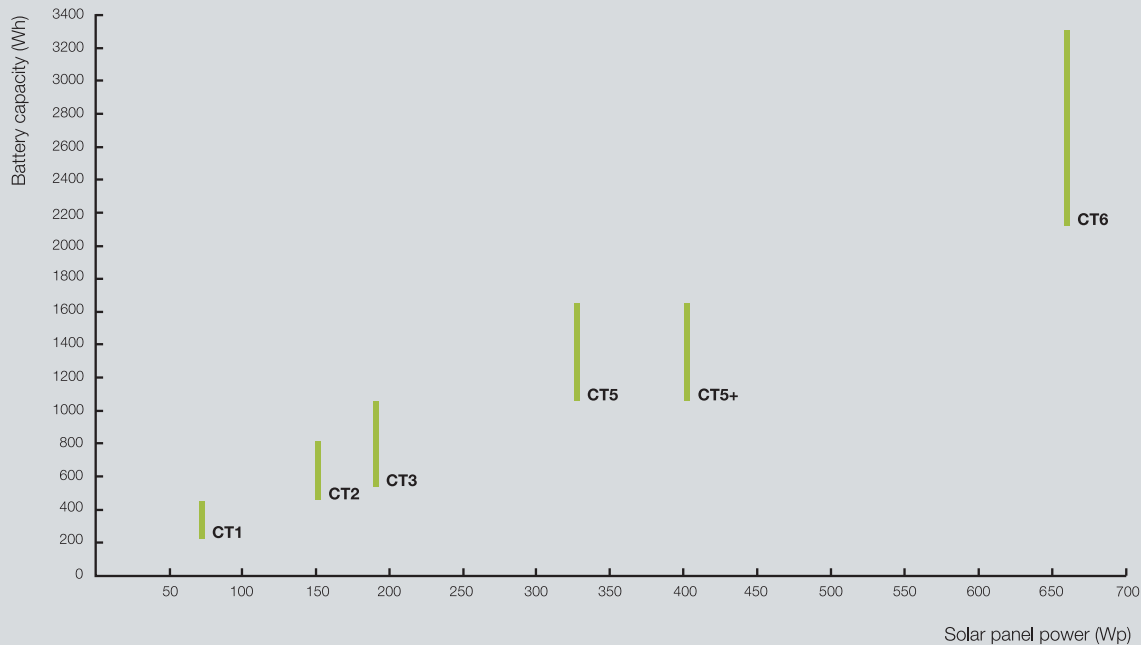

*CT = Combi Top

Battery capacity will be chosen according to the lighting power and time as well as the operating autonomy needed to meet the project requirements. Solar panel power will be sized according to the geographical area of the installation and to the energy consumption per night of the street lamp.

THE WIDEST AESTHETIC AND TECHNICAL RANGE ON THE MARKET

Tilt of the solar panel from 15° to 30° depending on the geographical area

Model	Light height	Bracket	Luminaire	Color
Combi Top 1	4 m	-	-	RAL 2900
Combi Top 2	5 m	Elina 50	Deiko S	RAL 1019
Combi Top 3	6 m	Ka 60	Deiko S	RAL 9005
Combi Top 5	8 m	Ka 75	Griff XL	RAL 2900
Combi Top 6	8 m	St Luc 50 - double	Tekk M	RAL 2900



endurance+
TECHNOLOGY

More information p.32



**RUGGED AND LONG-
LASTING BATTERY**



**LIMITED
MAINTENANCE**



**SMART
OPERATING**



**PLUG
AND LIGHT**



**HIGH PERFORMANCE
LED LIGHTING**



**MADE
IN FRANCE**

- 1 **A high performance solar panel**, self-cleaning. Tilt at 360° and sized for an optimal energy production all over the year.
- 2 **Batterie Endurance + Technology**, developed by Novéa in partnership with CEA. Lithium Iron Phosphate technology offers a unique service life. It resists perfectly to extreme temperatures (-20°C to +65°C). Sized to operate all year long with the same level of efficiency. Its cast aluminium box gives robustness and longevity.
- 3 **The circuit board (NOVEMS controller)**, is the brain of solar lighting set. Designed by our RD department, it enables an optimal and adapted management of the battery and the lighting. Its high energy efficiency offers a perfect sizing of solar panel and battery.
- 4 **LED luminaire** in compliance with public lighting standard (aluminium foundry, flat toughened glass). Its luminous efficiency up to 180 lm/W and its lifetime of more than 100 000 hours, give power and durability.
- 5 **Poles and mechanical supports** are sized according to EN 40 norm and Eurocode 1991-1-4 by our qualified mechanical office. It ensures robustness, safety and longevity of the solar street light.

COMBI TOP 1



Battery location

endurance+
TECHNOLOGY

APPLICATIONS

- Bus stop
- Residential
- Pedestrian path
- Bicycle path

TECHNICAL CHARACTERISTICS

Solar panel power		minimum 60 Wp
Solar panel tilt	Tilt at 15°	Lat 25° N < installation zone < Lat 25° S
	Tilt at 30°	installation zone > Lat 25° N or installation zone > Lat 25° S
Light height		3,5 to 6 m
Endurance + Technology battery capacity		214 to 436 Wh
Lighting power		5 to 20 W
Lighting flux		700 to 3 600 lumens
Luminous efficiency		140 lm/W (2 200 K) - 160 lm/W (2 700 K) 165 lm/W (3 000 K) - 180 lm/W (4 000 K)
Color temperature		2 200 K, 2 700 K, 3 000 K or 4 000 K (others on request)
Operating temperature		-20 °C / +65 °C
Lighting management		dusk sensor, time slots, dimming mode motion sensor integrated in the luminaire optional
Service life		cf. warranties and lifetime brochure
Materials		cast aluminium, tempered glass protection polycarbonate optional, stainless steel screws and bolt
SCx and weight of the solar module and luminaire	SC _x	0,288 m ² (15° tilted solar panel version) 0,432 m ² (30° tilted solar panel version)
	Weight	21 kg (battery at 214 Wh) 23 kg (battery at 436 Wh)

Solar module and luminaire to be mounted on cylindrical-conical pole in top 60 or 90 mm

Combi Top 1

Light height :
5 m

Luminaire :
Combi Top 1
RAL 2900



For more information

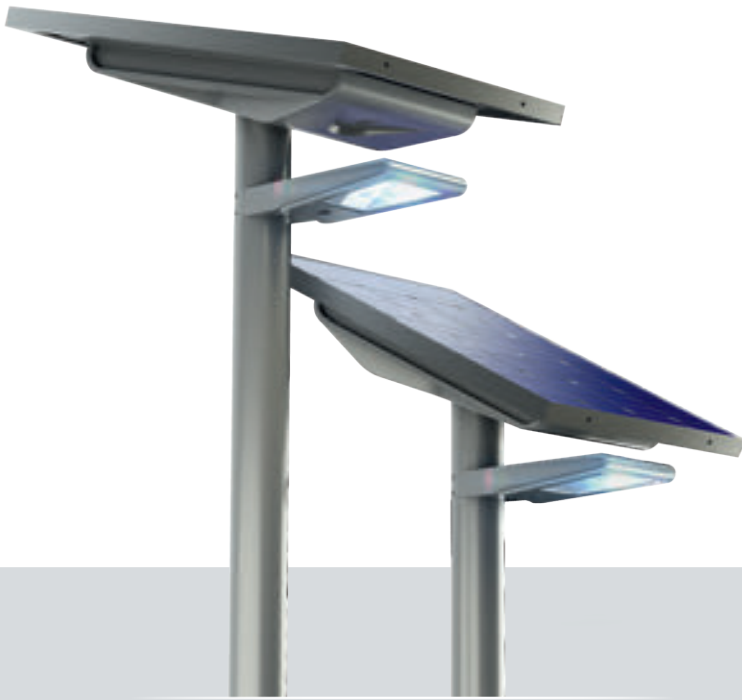

Tilt of the solar panel from 15° to 30° depending on the geographical area



France

8 m

7 m

6 m

5 m

4 m

3 m

2 m

1 m



Combi Top 1

Light height :
3,5 m
RAL 9010

Combi Top 1

Light height :
4 m
RAL 2900

Combi Top 1

Light height :
5 m
RAL 1019

COMBI TOP 2

Battery location

endurance+
TECHNOLOGY

APPLICATIONS

- Bus stop
- Residential
- Car park
- Pedestrian path
- Bicycle path

TECHNICAL CHARACTERISTICS

Solar panel power		minimum 150 Wp
Solar panel tilt	Tilt at 15°	Lat 25° N < installation zone < Lat 25° S
	Tilt at 30°	installation zone > Lat 25° N ou installation zone > Lat 25° S
Light height		4 to 6 m
Endurance + Technology battery capacity		428 to 819 Wh
Lighting power		10 to 40 W
Lighting flux		1 400 to 7 200 lumens
Luminous efficiency		140 lm/W (2 200 K) - 160 lm/W (2 700 K) 165 lm/W (3 000 K) - 180 lm/W (4 000 K)
Color temperature		2 200 K, 2 700 K, 3 000 K or 4 000 K (others on request)
Operating temperature		-20 °C / +65 °C
Lighting management		dusk sensor, time slots, dimming mode motion sensor optional
Service life		cf. warranties and lifetime brochure
Materials		cast aluminium, tempered glass protection polycarbonate optional, stainless steel screws and bolt

Combi Top 2

Light height :
6 m

Bracket :
Mcp

Luminaire :
Griff S
RAL 2900



For more information



New-Caledonia

Tilt of the solar panel from 15° to 30° depending on the geographical area

8 m

7 m

6 m

5 m

4 m

3 m

2 m

1 m



COMBI TOP 3

Battery location

endurance+
TECHNOLOGY

APPLICATIONS

- Bus stop
- Residential
- Car park
- Pedestrian path
- Bicycle path
- Secondary road

TECHNICAL CHARACTERISTICS

Solar panel power		minimum 175 Wp
Solar panel tilt	Tilt at 15°	Lat 25° N < installation zone < Lat 25° S
	Tilt at 30°	installation zone > Lat 25° N ou installation zone > Lat 25° S
Light height		4 to 8 m
Endurance + Technology battery capacity		532 to 1064 Wh
Lighting power		20 to 40 W
Lighting flux		2 800 to 7 200 lumens
Luminous efficiency		140 lm/W (2 200 K) - 160 lm/W (2 700 K) 165 lm/W (3 000 K) - 180 lm/W (4 000 K)
Color temperature		2 200 K, 2 700 K, 3 000 K or 4 000 K (others on request)
Operating temperature		-20 °C / +65 °C
Lighting management		dusk sensor, time slots, dimming mode motion sensor optional
Service life		cf. warranties and lifetime brochure
Materials		cast aluminium, tempered glass protection polycarbonate optional, stainless steel screws and bolt

Combi Top 3

Light height :
6 m

Bracket :
St Luc 50

Luminaire :
Tekk S
RAL 1019



For more information



Gabon

Tilt of the solar panel from 15° to 30° depending on the geographical area

8 m

7 m

6 m

5 m

4 m

3 m

2 m

1 m

Combi Top 3

Light height :
5 m

Bracket :
Elina 30

Luminaire :
Loxo C
RAL 9010

**Combi Top 3**

Light height :
6 m

Bracket :
Ka 60

Luminaire :
Deiko S
RAL 9005

Combi Top 3

Light height :
6 m

Bracket :
St Luc 50

Luminaire :
Bento S
RAL 2900

Combi Top 3

Light height :
7 m

Bracket :
St Luc 50

Luminaire :
Tekk S
RAL 1019

Combi Top 3

Light height :
6 m

Bracket :
Mcp - double

Luminaire :
Griff S
RAL 1019

COMBI TOP 5/5+

Battery location

endurance+
TECHNOLOGY

APPLICATIONS

- Secondary road
- Main road
- Car park

TECHNICAL CHARACTERISTICS

Solar panel power	minimum 330 Wp (390 Wp for Combi Top 5+)	
Solar panel tilt	Tilt at 15°	Lat 25° N < installation zone < Lat 25° S
	Tilt at 30°	installation zone > Lat 25° N ou installation zone > Lat 25° S
Light height	5 to 8 m	
Endurance + Technology battery capacity	1 064 to 1 638 Wh	
Lighting power	30 to 60 W	
Lighting flux	4 200 to 10 800 lumens	
Luminous efficiency	140 lm/W (2 200 K) - 160 lm/W (2 700 K) - 165 lm/W (3 000 K) - 180 lm/W (4 000 K)	
Color temperature	2 200 K, 2 700 K, 3 000 K or 4 000 K (others on request)	
Operating temperature	-20 °C / +65 °C	
Lighting management	dusk sensor, time slots, dimming mode motion sensor optional	
Service life	cf. warranties and lifetime brochure	
Materials	cast aluminium, tempered glass protection polycarbonate optional, stainless steel screws and bolt	

Combi Top 5

Light height :
6 m

Bracket :
Ka 75

Luminaire :
Deiko M
RAL 2900



For more information



La Réunion

Tilt of the solar panel from 15° to 30° depending on the geographical area

8 m

7 m

6 m

5 m

4 m

3 m

2 m

1 m

Combi Top 5

Light height :
6 m

Bracket :
Elina 50

Luminaire :
Deiko M
RAL 9010

Combi Top 5

Light height :
7 m

Bracket :
St Luc 70

Luminaire :
Bento M
RAL 2900

Combi Top 5

Light height :
8 m

Bracket :
St Luc 70

Luminaire :
Loxo C
RAL 1019

Combi Top 5

Light height :
8 m

Bracket :
Ka 75

Luminaire :
Griff XL
RAL 2900

Combi Top 5

Light height :
8 m

Bracket :
St Luc 50 - double

Luminaire :
Tekk M
RAL 1019



COMBI TOP 6

Battery location

endurance+
TECHNOLOGY

APPLICATIONS

- Secondary road
- Main road
- Car park

TECHNICAL CHARACTERISTICS

Solar panel power		minimum 660 Wp (2*330)
Solar panel tilt	Tilt at 15°	Lat 25° N < installation zone < Lat 25° S
	Tilt at 30°	installation zone > Lat 25° N ou installation zone > Lat 25° S
Light height		5 to 8 m
Endurance + Technology battery capacity		2 128 to 3 276 Wh
Lighting power		30 to 120 W
Lighting flux		4 200 to 21 600 lumens
Luminous efficiency		140 lm/W (2 200 K) - 160 lm/W (2 700 K) - 165 lm/W (3 000 K) - 180 lm/W (4 000 K)
Color temperature		2 200 K, 2 700 K, 3 000 K or 4 000 K (others on request)
Operating temperature		-20 °C / +65 °C
Lighting management		dusk sensor, time slots, dimming mode motion sensor optional
Service life		cf. warranties and lifetime brochure
Materials		cast aluminium, tempered glass protection polycarbonate optional, stainless steel screws and bolt

Combi Top 6

Light height :
8 m

Bracket :
Atinia 6600

Luminaire :
Elina 70
RAL 2900



For more information



France

Tilt of the solar panel from 15° to 30° depending on the geographical area

8 m

7 m

6 m

5 m

4 m

3 m

2 m

1 m

Combi Top 6

Light height :
8 m

Bracket :
St Luc 50

Luminaire :
Deiko S
RAL 2900

Combi Top 6

Light height :
7 m

Bracket :
St Luc 50

Luminaire :
Tekk S
RAL 9010

Combi Top 6

Light height :
7 m

Bracket :
St Luc 70

Luminaire :
Loxo C
RAL 2900

Combi Top 6

Light height :
7 m

Bracket :
St Luc 70 - double

Luminaire :
Tekk S
RAL 2900



DECORATIVE FUNCTIONAL DESIGN

8 m

7 m

6 m

5 m

4 m

3 m

2 m

1 m



Combi Top 2

Light height :
4 m
Bracket :
Mcp
Luminaire :
Griff S
RAL 2900

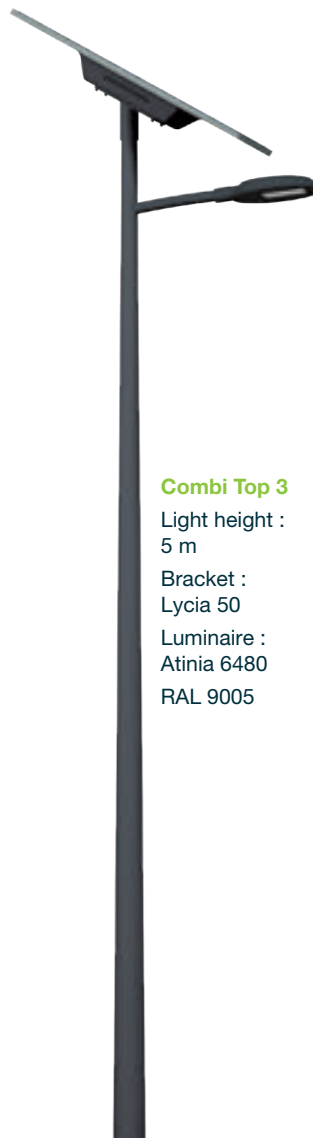

Combi Top 3

Light height :
5 m
Bracket :
Lycia 50
Luminaire :
Atinia 6480
RAL 9005

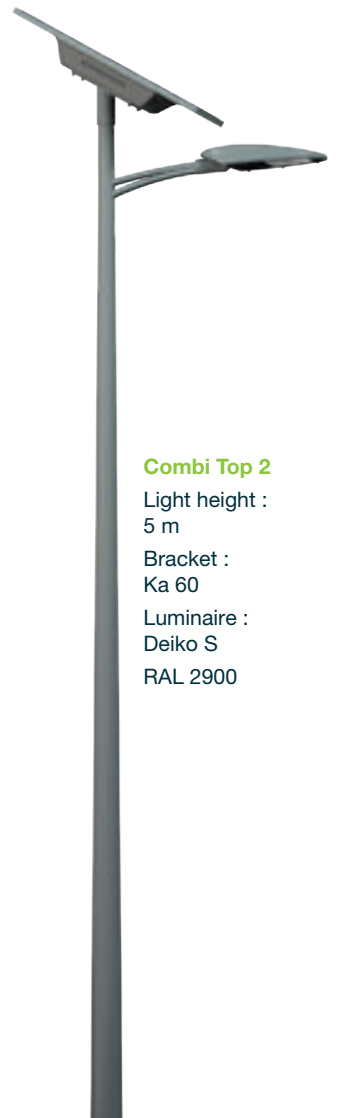

Combi Top 2

Light height :
5 m
Bracket :
Ka 60
Luminaire :
Deiko S
RAL 2900

“ YOUR SOLAR STREET LAMP IN YOUR IMAGE ”



Combi Top 3

Light height :
6 m
Bracket :
St Luc 50
Luminaire :
Bento S
RAL 2900

Combi Top 5

Light height :
7 m
Bracket :
Lathonia 70
Luminaire :
Tekk M
RAL Dark green

Combi Top 5

Light height :
7 m
Bracket :
Ka 75
Luminaire :
Pulse
RAL Blue and White

Combi Top 5

Light height :
7 m + 4m
Bracket :
Elina 70 - Mcp
Luminaire :
Griff XL et S
RAL 1019

Tilt of the solar panel from 15° to 30° depending on the geographical area

AMBIANCE DESIGN

8 m

7 m

6 m

5 m

4 m

3 m

2 m

1 m

Combi Top 3

Light height :
3,5 m

Bracket :
Lycia 70

Luminaire :
Fragment
RAL 2900

Combi Top 2

Light height :
4 m

Bracket :
Atilis 70

Luminaire :
Chic
RAL Red

Combi Top 3

Light height :
5 m

Bracket :
Lycia 50

Luminaire :
Emblème
RAL 9005

Combi Top 3

Light height :
5 m

Bracket :
Rome 50

Luminaire :
Lampion
RAL 2900



“ A STRONG IDENTITY THROUGH
UNIQUE STREET FURNITURE ”

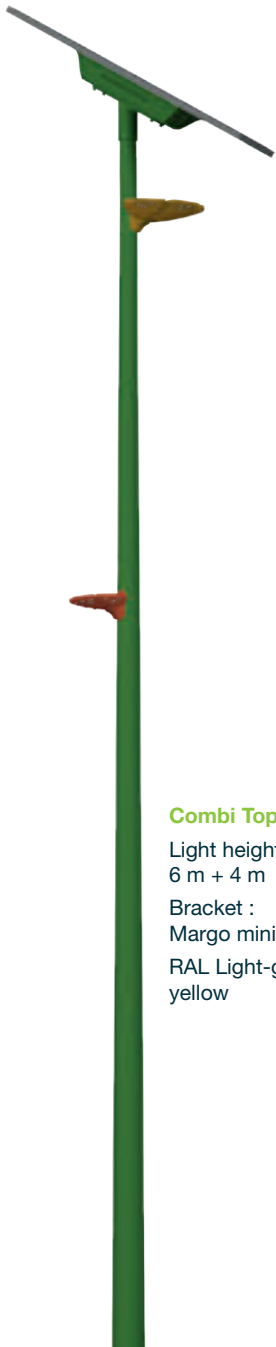

Combi Top 3

Light height :
6 m + 4 m

Bracket :
Margo mini and mega
RAL Light-green, red and
yellow



Combi Top 3

Light height :
6 m

Bracket :
Robora 75
Luminaire :
Atinia 6600
RAL 1019

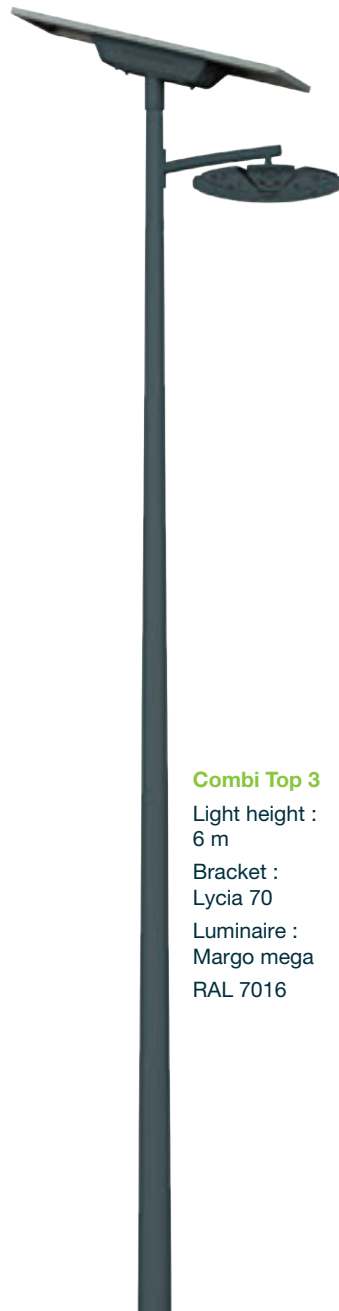

Combi Top 3

Light height :
6 m

Bracket :
Lycia 70
Luminaire :
Margo mega
RAL 7016



Combi Top 5

Light height :
7 m

Bracket :
Irys x 2 ou 4
RAL 2900

Tilt of the solar panel from 15° to 30° depending on the geographical area

TRADITIONAL DESIGN

“ THE ALLIANCE BETWEEN
ADVANCED TECHNOLOGY
AND ARCHITECTURAL
HERITAGE ”



Tilt of the solar panel from 15° to 30° depending on the geographical area

TECHNICAL SPECIFICATIONS



BATTERY ENDURANCE + TECHNOLOGY



The longest service life on the market

8 000 cycles at 30 % DoD at 25°C i.e. > 20 years
4 000 cycles at 40 % DoD at 35°C i.e. > 10 years



Fully functional at extreme temperatures

Thanks to special cells, our LiFePO₄ batteries operate down to -20°C, up to +65°C.



Maximum energy efficiency

Reduction of the required nominal capacity compared to other types of technologies (NiMh and Lead) thanks to better usage rate and yield.



More environmentally friendly

The components used (aluminium for the box, Lithium, Iron and Phosphate) limit the environmental impact during production and facilitate recycling. Besides, our Lithium Iron Phosphate technology does not use heavy and pollutants metals.



endurance+
TECHNOLOGY

LITHIUM

Circuit board

Fast connectors
(solar panel & luminaire)

Lithium Iron Phosphate cells

Cast aluminium box (IP66)

cea

Endurance+ technology, designed by Novéa in partnership with the CEA of Grenoble, offer the best lifespan of the market thanks to its lithium LiFePO₄ cells and its unique management of energy flows. LiFePO₄ batteries have been documented by scientists as most efficient and most suitable for public solar lighting market.

PHOTOMETRY

Possible color temperatures :
Amber, 2 200 K, 2 700 K , 3 000 K, 4 000 K

To optimise street lamps establishment, Novéa propose different photometric distributions. The choice of these optics will be validated by a precise photometric study realised by our design office.



ROAD ASYMMETRICAL DISTRIBUTION

High performance road lighting. Functional distribution allows precisely target the area to light and to limit the glare.

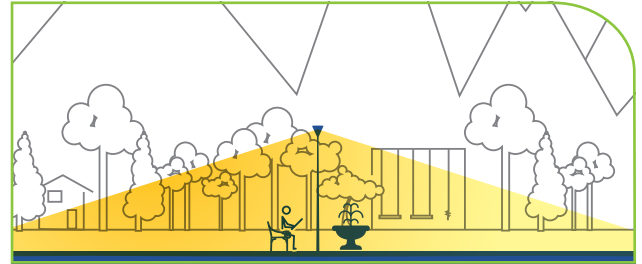

SYMMETRICAL DISTRIBUTION

Lighting of streets in city centres, squares, car parks and pedestrian areas. Optimised solution for axial installations (on central reservation, between pavement and bicycle path).

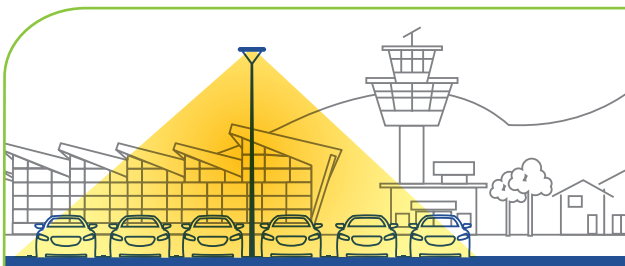

CIRCULAR DISTRIBUTION

Residential lighting of squares, car parks, city centres, pedestrian areas and parks. Optimised solution for comfort, it's particularly adapted to central installation.



PEDESTRIAN CROSSING DISTRIBUTION

Precise lighting which direct the light on the side of the protected area. It provides a strong contrast between the pedestrian and the pavement.

Being part of Ragni Group allows us to offer **the widest range on the market** thanks to the expertise of the Ragni company, a French lighting manufacturer since 1927.

FUNCTIONAL LUMINAIRES



TEKK

BENTO

GRIFF



LOXO C

DEIKO

PULSE



ATINIA SLIM

CIRKO FLEX

ARO

DESIGN LUMINAIRES



MARGO

CIRKO

CHIC

LAMPION

TRADITIONAL LUMINAIRES



VENCE

SOPHIA

EMBLEME

ROGNAC

CONSUMPTION CONTROL BY LIGHTING MANAGEMENT

To optimise the sizing, the cost and to save resources, we recommend an energy-efficient operating system, the most suitable for your needs. This lighting management is configured to have lighting adapted to the request.

In presence detection mode, it is necessary to start from an assumption of number of passages where the luminaire will be at full power. In the event that the duration at full power exceeds that which we had estimated in the study, the luminaire will remain in dimming mode to limit the discharge of the battery and preserve its lifespan.

TYPICAL DIAGRAMS

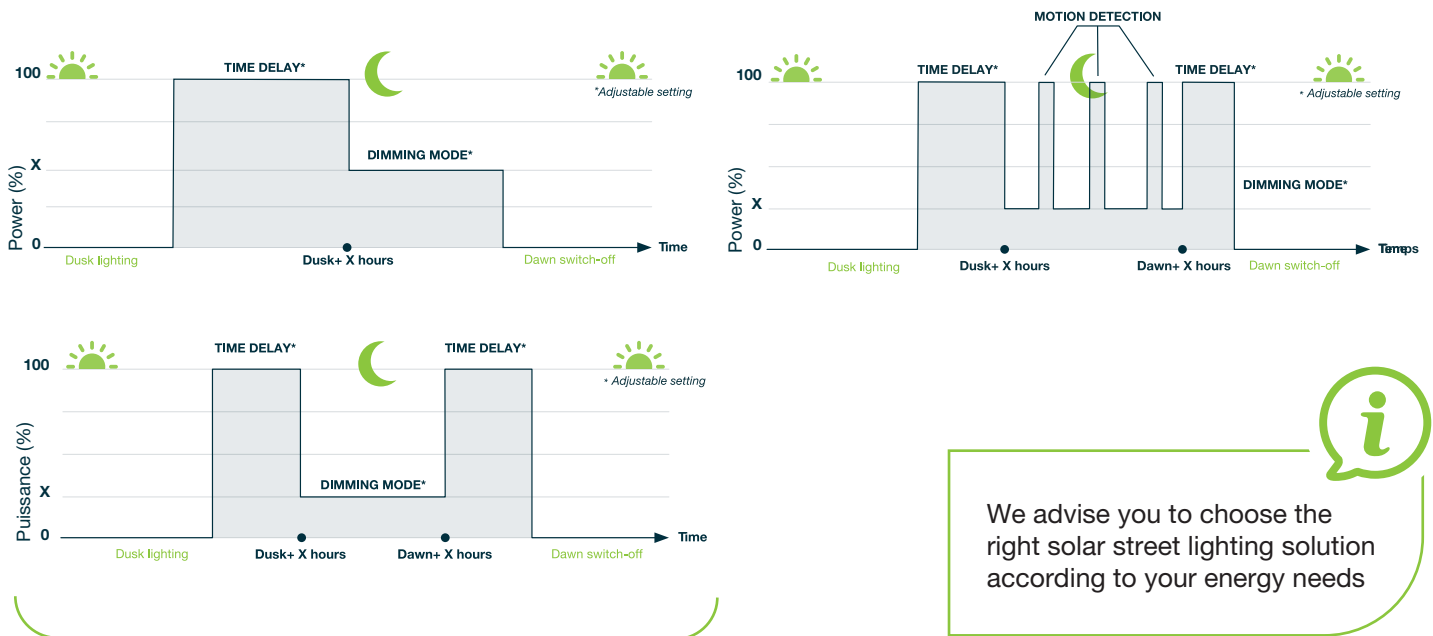

We advise you to choose the right solar street lighting solution according to your energy needs

MANAGEMENT EQUIPMENT:



CLOCK PROGRAMMING



REMOTE CONTROL AND MANAGEMENT



MOTION DETECTION



SWITCH ON/OFF



DIMMING

OUR POLE WITHOUT VISIBLE WELD

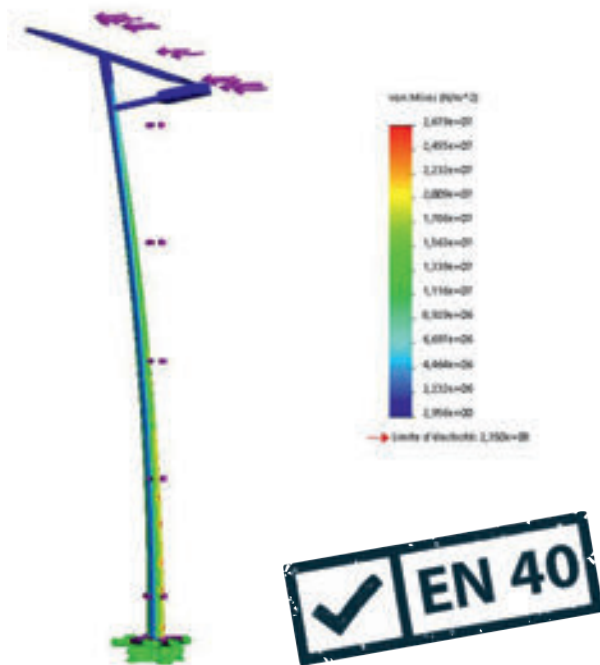

Our mechanical studies realised at the start of the project enable us to set the technical characteristics of the pole and its concrete support according to EN 40 norm (public lighting support).

Novéa realises its calculation note in compliance with EN 40 and integrate the fatigue according to the EUROCODE 1991-1-4 part 2 (solar equipments sensitive to wind on lighting support).

So Novéa respect the technical recommendations of CTICM (Industrial Technical Centre of Mechanical Construction).

This technical approach allows us to realise a sustainable and safe installation.

ERW METHOD FOR INVISIBLE WELD

The ERW method intervenes when the two sides of the preformed cone trunk are welded to constitute the pole. It involves heating the edges of the two sides with high frequency electricity until merger temperature.

The sides will then be pressed with rollers to merge.

This welding without additional metal results invisible, for a high quality finish.

STRONG POINTS



INVISIBLE WELD THANKS TO ERW METHOD



BEST QUALITY STEEL UNTIL S 355 AND WITH CHARACTERISTICS MEETING EN 10025 REQUIREMENTS



OPTIMISED PRODUCTION STEPS TO LIMIT CO₂



CERTIFIED EN 40 AND EUROCODE 1991-1-4 TO ENSURE THE ROBUSTNESS OF THE PRODUCT

POLES TREATMENTS

STANDARD TREATMENTS

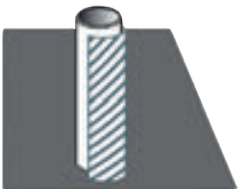

Hot galvanisation

All of our poles comply with this treatment.

The pole is dived in a bath of Zinc which merges with steel and becomes a protective layer against light and medium corrosion. The thickness has to be minimum at 55 micrometres and reach on average 70 micrometres. This process respects ISO 1461 norm.

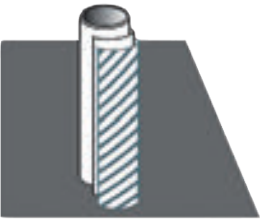

Powder coating

A process with no solvent which consists of spraying a thermosetting powder painting and in baking it. It enables to protect the pole against bad weather and UV rays, and give effects (metallised, textured,...). It complies with ISO 12944.

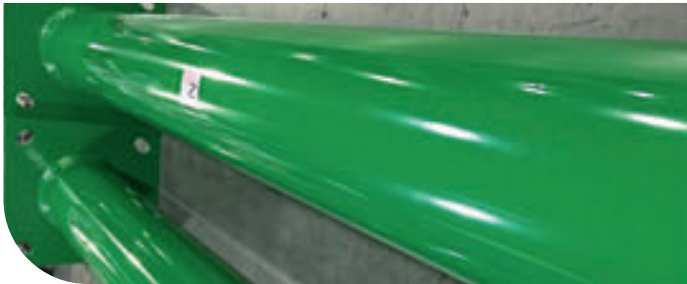

SPECIFIC TREATMENTS

Seashore treatment

This layer aims to reinforce the protection for areas with high and extreme corrosion risk. It is realised by adding, before powder coating, an epoxy preparation of 80 micrometres and then baking it.

Sublimation

This sublimation enables to add a wood effect on the pole, for a natural finish.

To add this finishing touch, a transfer film is applied on the pole, then heated between 180°C and 200°C. The texture reek of the painting, then the film is removed. The final texture is harmonious and offers an excellent robustness over time.

This finish is realised on Ragni Group site.





4

OPTIONS

NOVLOAD

USB CHARGING MODULE FOR MOBILE PHONE



The NOVLOAD USB charging module, designed by Novéa Energies, is a very practical service in isolated areas and complementary to lighting.

The NOVLOAD module designed and developed by Novéa, is a solution for charging USB devices such as mobile phones.

Smart

Once the battery is fully charged, the excess energy produced by the solar panels powers the USB module.

A blue backlight indicates the availability of the service.

Lighting priority

A regulation enables to cut the power supply of the USB module to ensure that the lighting function is maintained at night, without degradation.

Robust

This aluminium casting module is easily attachable to one of our solar poles.

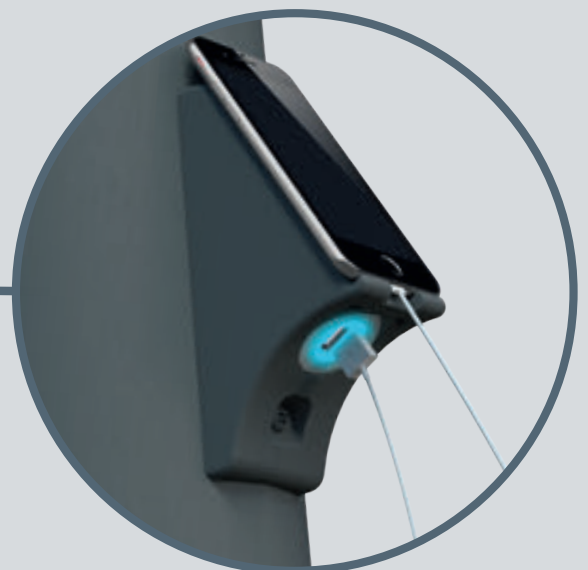

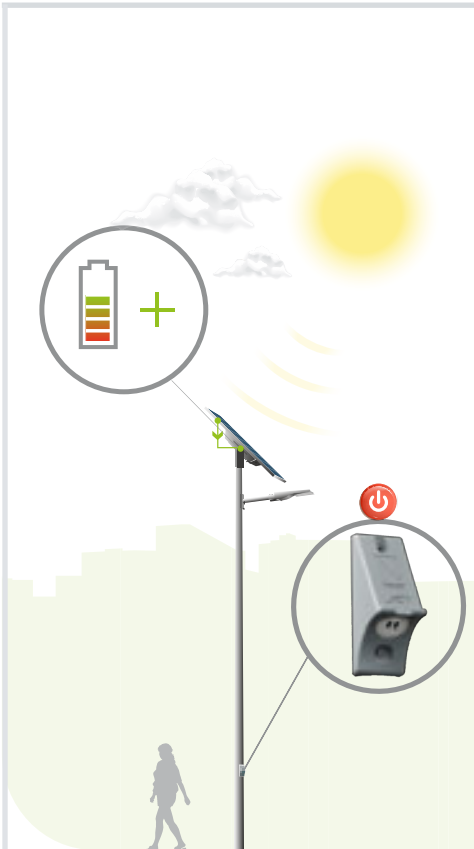

Energy production

NOVLOAD is not available if the battery is not sufficiently charged.

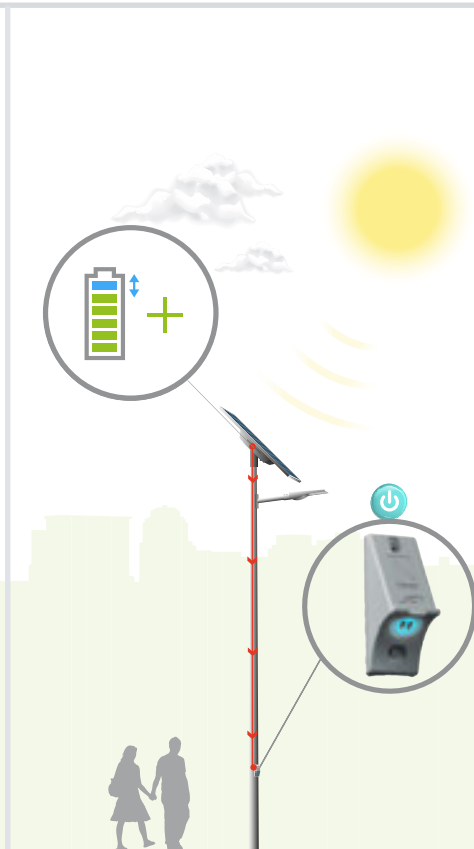

Battery charged to the maximum

Once the battery is charged, NOVLOAD provides energy until a fixed threshold.

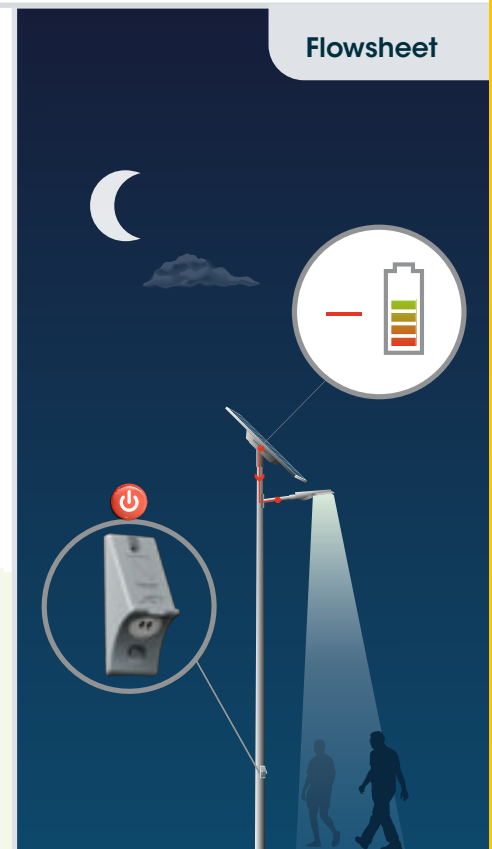

Energy consumption

NOVLOAD is not available at night, when the battery powers the luminaire.



- Mechanical part in aluminium foundry, personalised RAL
- Two USB ports, 10 W
- Visual indicator on the module to notify the availability of the service



NOVCOM Z

LIGHTING MONITORING SYSTEM



Our communicating unit NOVCOM Z

Installed on a Zhaga base – usually placed on the luminaire.

Compatible luminaires: LOXO C, TEKK S / M, BENTO S/ M, GRIFF S and DEIKO S.

For the other luminaires and the CT1 model, the node will be integrated on the top of the solar panel.

For the CT6, 1 communicating module per solar panel/battery.

The sensors are perfectly waterproof (IP66) to resist external constraints.

The NOVCOM Z offers 3 complementary intelligent functions for efficient lighting management:

Communicating detection - page 41

NOVMOOV

Communicating detection.
Local inter-pole mode.

2 management levels - pages 43 and 44

NOVEA LINK

Management of each lighting point at the foot of the pole via an application.

NOVEA CONTROL
by SEV®

Remote management of solar street lights.
Additional equipment required (gateway) + platform subscription

NOVMOOV

COMMUNICATING MOTION DETECTION SYSTEM

Since 2007, Novéa has always integrated the motion detection function into its solar lighting solutions in order to optimise the dimensioning of the components and their lifetime.

With this NOVMOOV module, Novéa offers a wireless communicating solution that allows one or more groups of street lamps to be switched on simultaneously in full power.

Advantages

- **Optimum lighting** adapted only to the user's needs
- **Secure function**
- **Limit light pollution**
- **Substantial energy savings** when there is no user
- **Reduced cost of solar street lamp** thanks to more reasonable sizing of solar panels and batteries
- **Increased autonomy of the street light**
- **Environmental protection** thanks to an approach aiming to sustainability and resources' savings

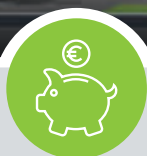

Savings



Comfort and safety



**Environmentally
friendly**

An innovative solution

NOVMOOV is a local wireless communication system between luminaires to adapt lighting.

Luminaires are operating in dimming mode to ensure markup.

When a user is approaching, the NOVMOOV motion sensor switches instantaneously on full power lighting for a group of luminaires.

On the same project, several lighting groups can be managed.

A luminaire can be part of several groups.

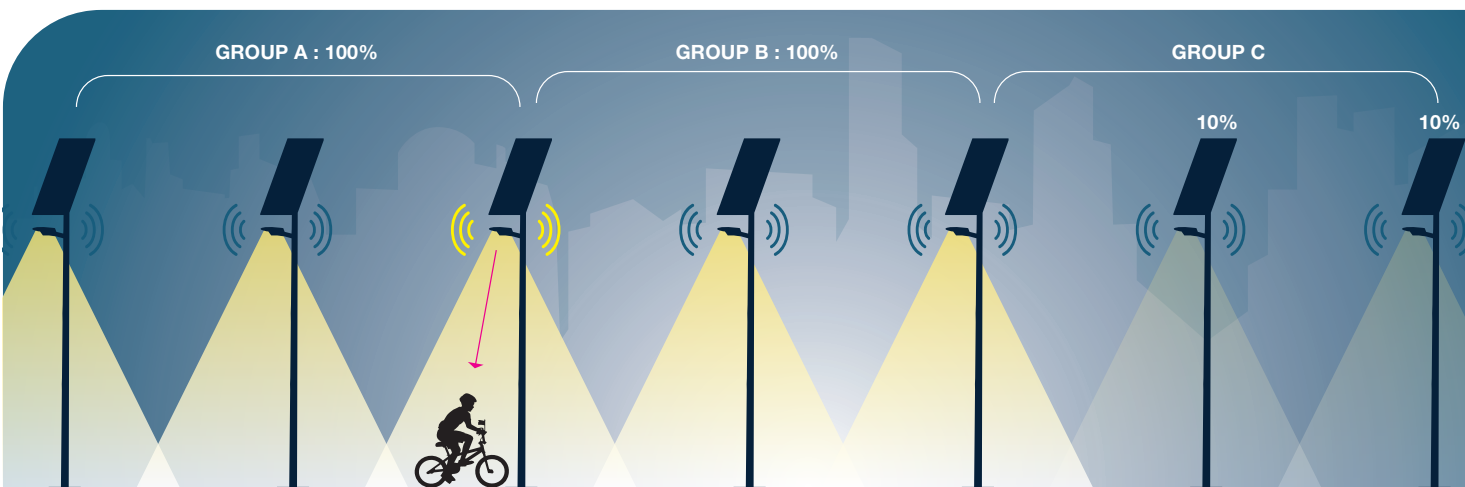

The NOVMOOV sensor detects a user approaching, one or more luminaires groups switches from dimming mode to full-power mode.

Luminaires in dimming mode to save energy

Example of communicating lighting between street lights.

Main characteristics

360° maximum detection area (120° per sensor, up to 3 sensors per street lamp).

NOVMOOV motion sensors use infrared technology. This technology consists of analysing the movements and the heat.

360° maximum detection area

360° Angle with 3 sensors

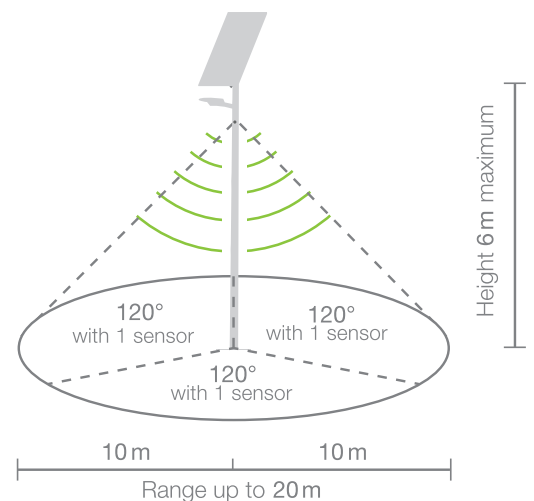

NOVEA LINK BLUETOOTH® MANAGEMENT SYSTEM AT THE FOOT OF THE POLE

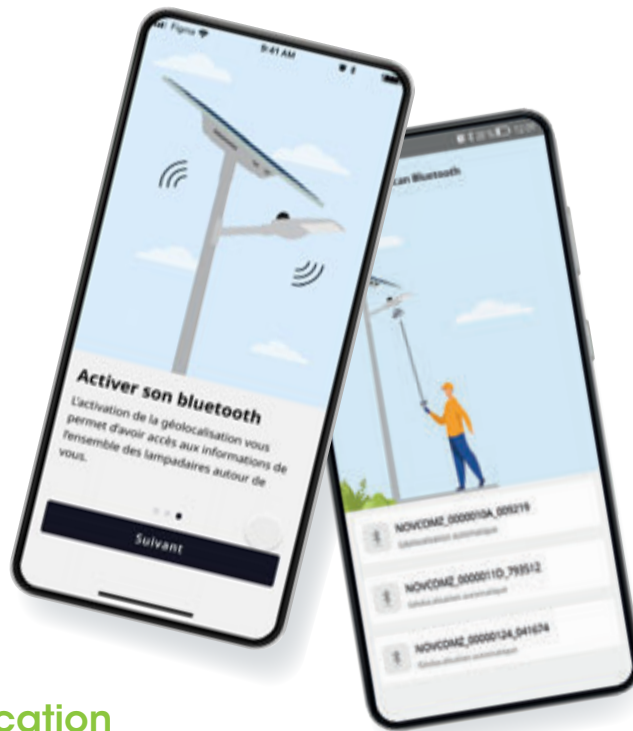
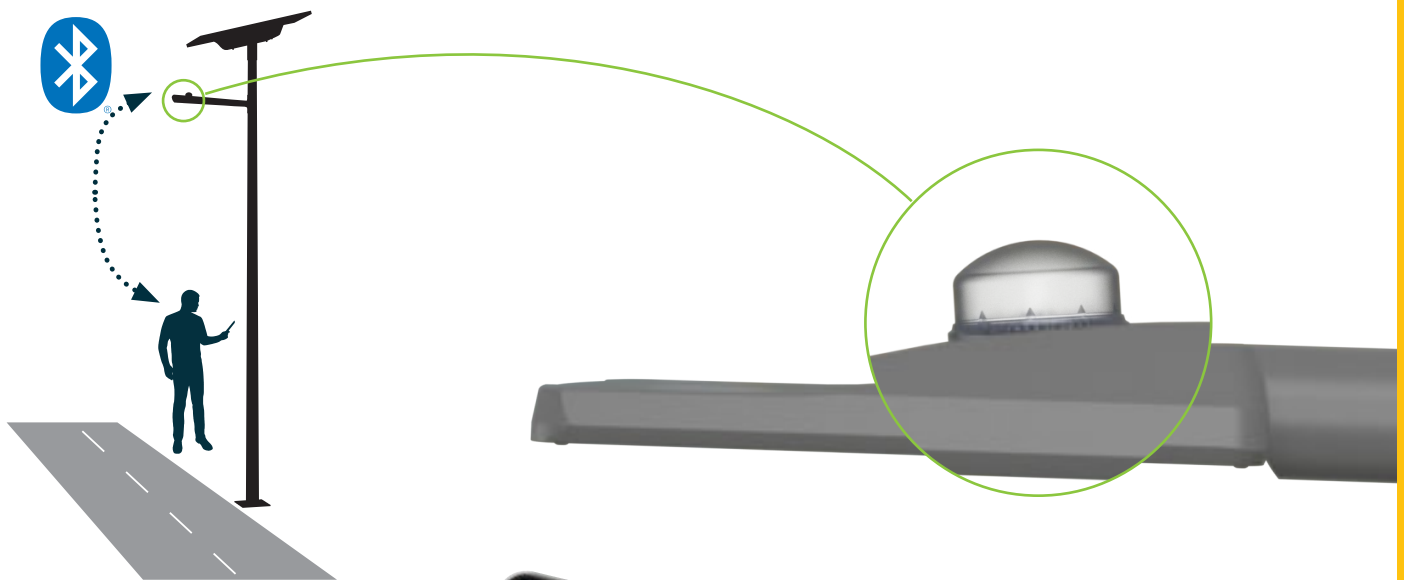

The Bluetooth® application allows to:

- Collect operating information (battery charge status, faults, etc.) from the pole paired with the smartphone.
- Facilitate after-sales service requests from the Novea Energies support service.

NOVEA CONTROL

by SEV^e

REMOTE
MANAGEMENT



Set-up and subscription costs to be expected to access the platform

The SEV^e platform will give you access to:

- Bright spots geolocation
- Performance measures (charged and discharged energy, power and duration of the charge, history storage by street light, etc.)
- Abnormal performances analysis, defect (solar panel clogging, lighting defect, etc.)



**OUR
ACHIEVEMENTS**

57



Bridge
Combi Top 5, Griff XL - Pont Womey - Benin



Road
Combi Top 3, Tekk S - Gabon



Residential
Combi Top 5, Griff XL - Bafoussam - Cameroon



Residential
Combi Top 3, Tekk S - Gabon

**AFRICAN CONTINENT
ACHIEVEMENTS**



Natural site
Combi Top 3, Tekk S - Gabon

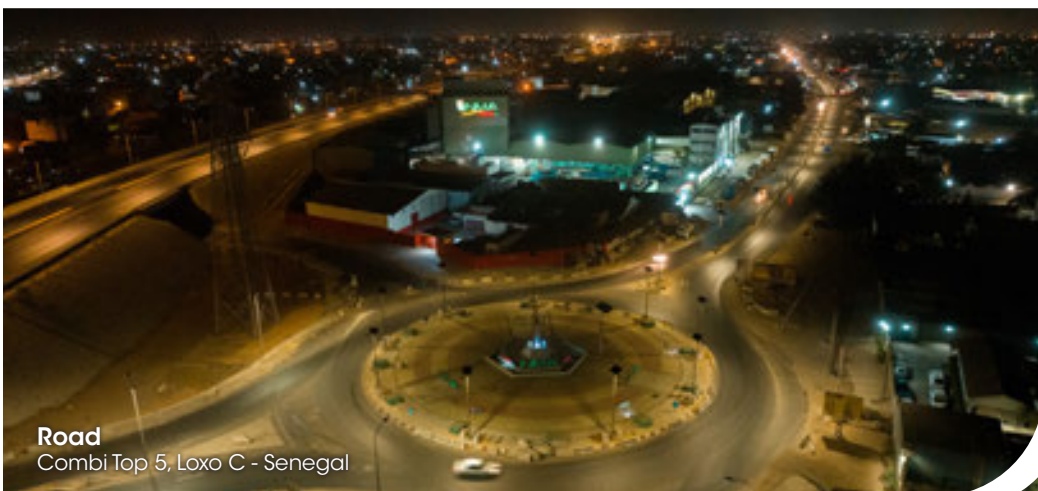

Road
Combi Top 5, Loxo C - Senegal

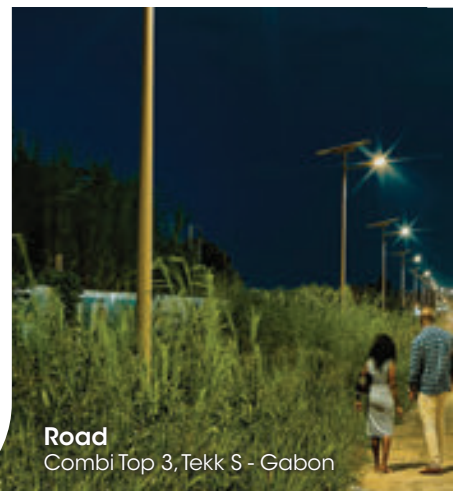

Road
Combi Top 3, Tekk S - Gabon



Bridge

Combi Top 5, Griff XL - Pont Bassam - Ivory Coast

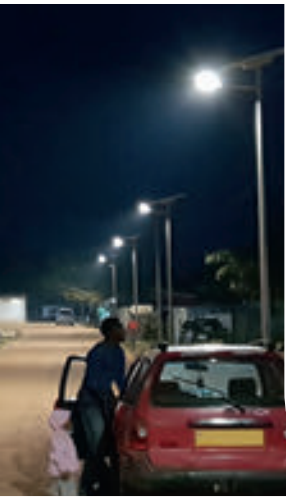

Residential

Combi Top 3, Griff S - Bingerville - Ivory Coast



Path

Combi Top 3, Tekk S - Gabon

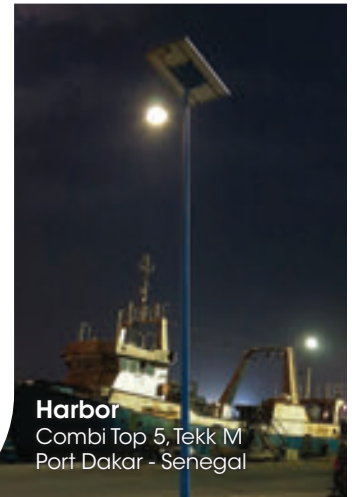

Harbor

Combi Top 5, Tekk M
Port Dakar - Senegal



Road

Combi Top 5, Griff XL - Traversée Agadez - Niger



Road
Combi Top 2 et 3, Tekk M - Les Trois-Îlets (Martinique)



Bus-stop
Combi Top 2, Griff S - Cheffes (49)



Pedestrian and bike path
Combi Top 3, Tekk S - Pont d'Ain (01)

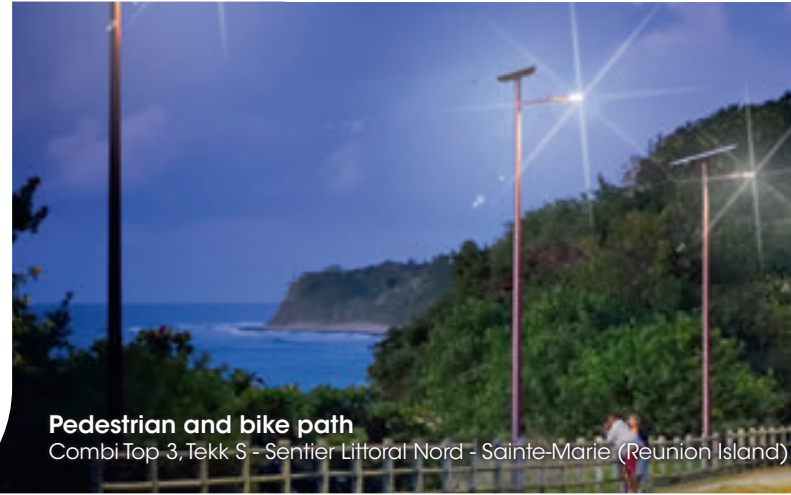

Pedestrian and bike path
Combi Top 3, Tekk S - Sentier Littoral Nord - Sainte-Marie (Reunion Island)

**FRANCE ACHIEVEMENTS
(OVERSEAS DEPARTMENTS
AND REGIONS)**



Park
Combi Top 3, Tekk S - Terrasson-Lavilledieu (24)



Car park
Combi Top 2, Tekk S - Béragne (11)



Residential
Combi Top 3 Tekk S - Saumur (49)



Rest area
Combi Top 5, Tekk S - Orléans (45)



Pedestrian crossing
Combi Top 3, Tekk S - Neuil les Aubiers (79)

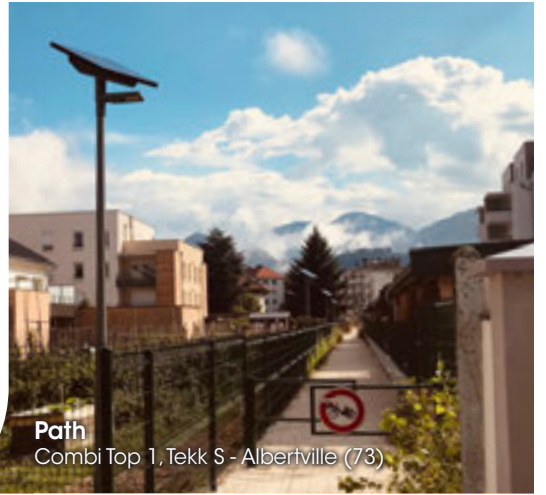

Path
Combi Top 1, Tekk S - Albertville (73)



Motorway interchange
Combi Top 6, Tekk M - Saint-Aybert (59)



City stadium
Combi Top 1,
Bécon-les-Granits (49)



Road
Combi Top 5, Griff XL, St Luc - Saint-André (Reunion Island)

SPECIFIC



Residential
Combi Top 3, Vence, Tropezienne -
Mareuil-sur-Lay-Dissais (85)



Residential
Combi Top 3, Vence, Sorea
(Corse)



Pedestrian and bike path
Multi Top 6, Tekk S - Eschau (67)



Platform
Combi Top 5, basculant, Tekk S - Combo-Les-Bains (64)



Stadium
Combi Top 3, Tekk S, St Luce - L'Étang-Salé (Reunion Island)



Natural site
Combi Top 2, Rognac, Sorea - Aussois (73)



6

**OUR
COMMITMENTS**

QSE MANAGEMENT AND POLICY



Develop qualitative solutions and limit their environmental impact

Committed in technological innovation, we use a scientific process to create and develop sustainable and reliable solutions. That is why we put our QSE (Quality, Security, Environment) management system in a continual improvement process, and we are certified with ISO 9001 and ISO 14001.

This scientific approach of autonomous lighting is enriched since 2011 by a partnership with the CEA of Grenoble and INES, reference centre dedicated to research and innovation in solar energy.



The French Alternative Energies and Atomic Energy Commission (CEA) is a public scientific, technical and industrial research organization (EPIC). From electric batteries to nanotechnologies, materials and biotechnology, the CEA Grenoble centre is at the cutting edge of technological research and actively commits in sharing its knowledge with the industry.

Development based on three approaches



Management and longevity



Durability and reliability of our products



Stakeholders and customers satisfaction

COMMITMENT IN SOLAR LIGHTING SECTOR

Membership to ADECC to promote circular economy

ADECC encourages companies to manufacture with better processes to optimise natural resources and to allow savings, which will be reinjected in actions for circular economy. For Novéa, this is applied as in the conception (local subcontracting, collaborate with sheltered workshops...) as in daily life (recycling of the different components of our products and of the supplies, internal awareness of environmental issues...)



Membership to lighting organisations to meet the demands of the sector

Being a member of these two organisations enables us to be aware of sector news: norms, innovations, market... and respond to our clients' needs, with a compliant and reliable product.

But we also want to promote off-grid lighting with all players, and to make accessible information about solar public lighting.



A COMPANY RESOLUTELY TURNED TO THE WORLD

Various projects worldwide

The alliance of our company with the Ragni Group, present in about forty countries, enabled us to develop our assets internationally, particularly in tropical and equatorial areas of the world. The exceptional solar potential of these countries and their great development opportunities are extremely promising for solar-powered lighting. That is why we believe we can provide our know-how to local public lighting companies.

Our partners are present in each country and we have opened two Ragni-Novéa subsidiaries on the African continent: one in Abidjan and one in Dakar. These local branches are a reflection of our informative and local approach. Our desire is to support all stakeholders throughout their project, and to develop their skills for optimal monitoring.

**“ THOUSANDS OF
REFERENCES AROUND
THE WORLD ”**

FRANCE



CYPRUS



NEW-CALEDONIA

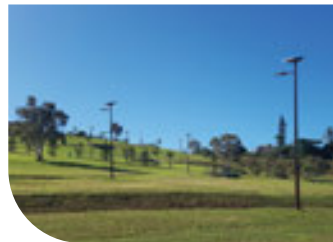

BENIN

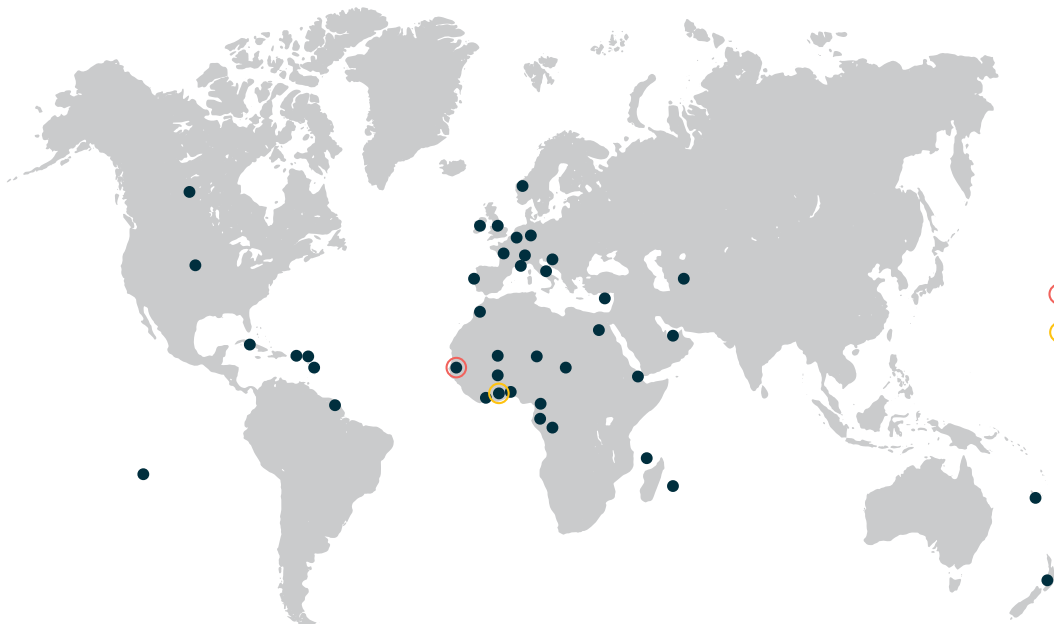

- Senegal subsidiary
- Ivory Coast subsidiary

MARTINIQUE



SENEGAL



GABON



REUNION ISLAND





ANGTI Gabon Project - A kebab seller extends her activity during the night thanks to Novéa street lamps

Safety and convenience of population: a fundamental

Public lighting is essential for social life:

- It reinforces security feeling of the population, who regains the places.
- It extends moments of community living.
- It stimulates economic activity of these areas.

But some parts of the world are still plunged into darkness, as no on-grid lighting solution can be installed.

Solar lighting is frequently the only alternative to light these areas and improve distinctly the life of the population.



Our humanitarian commitment

Aware of lighting issues worldwide and improvement that lighting development can bring, Novéa commits.

We are adherent and donating member of the association « Electriciens sans Frontières » who encourages economical and human development, using renewable energies.

We also support projects developed by a school in our territory in connection with an association and which aim to install electrical and hydraulic equipment in villages in Madagascar for example or in Togo.

At the same time, various sponsorship projects are carried out within Ragni Group. In 2019, we sent lighting poles in Senegal. Then, Louly association managed the installation in « La Pouponnière de M'bour », an association who protects orphans.





NOVEA

GROUPE RAGNI

*Solar Lighting,
designed to last*

NOVÉA ÉNERGIES

3, rue Joseph Fourier
49070 BEAUCOUZÉ - France
Tél. : +33(0)2 41 36 53 98

www.novea-energies.com



THIS BROCHURE IS RECYCLABLE,
it is printed on unlaminated paper.



As part of an ECO-RESPONSIBLE approach, this brochure
has been eco-designed for a limited use of inks.